

Elevation  
1 : 10

At the bottom, mount the starter batten in accordance with T-7 to offset tile thickness

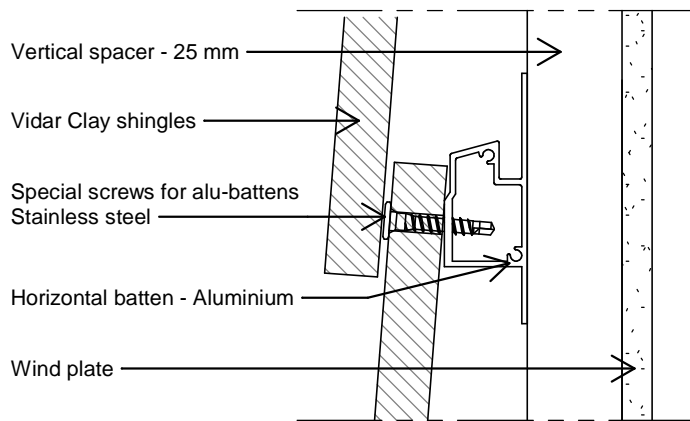

Vertical view  
1 : 2

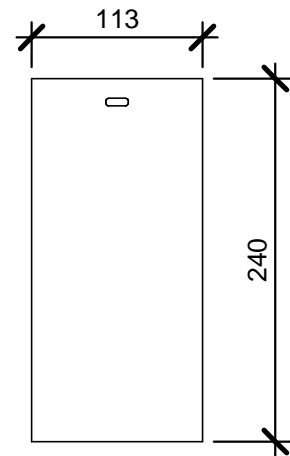

Clay Shingle  
1 : 5

The drawing is not to scale. All measurements are in mm.

Copyright © Komproment Danish Building Design

T-0	VIDAR		
Date: 01-01-2021	As indicated	<b>VIDAR Clay Shingles</b>	Tel.: +45 96520710 E-Mail: Export@komproment.dk Web: www.komproment.com

NOTE: Komproment makes these drawings available in the versions that currently exist. All use of the drawings is undertaken at own risk and liability. The drawings are regularly updated with relevant updates/changes on our website. You are responsible for keeping up-to-date with these changes. The drawings are made available in the following formats: PDF and DWG. All drawings are for guidance only. We make no guarantee that the drawings are suitable for all purposes.

**KOMPROMENT**  
DANISH BUILDING DESIGN

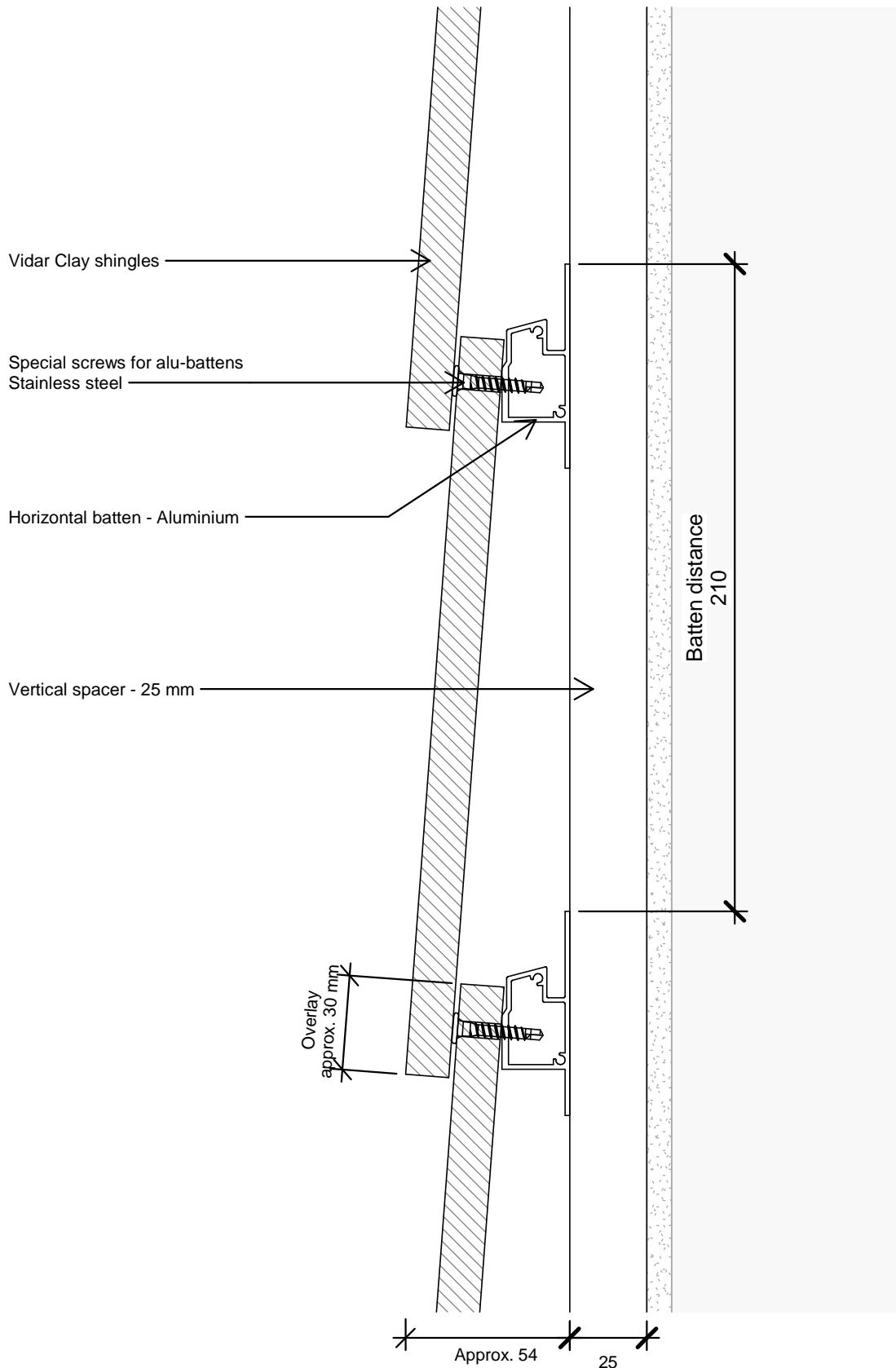

The drawing is not to scale. All measurements are in mm.

Copyright © Komproment Danish Building Design

T-1

Vertical view - alu-batten

Date: 01-01-2021

1 : 2

**VIDAR Clay Shingles**

Tel.: +45 96520710  
E-Mail: Export@komproment.dk  
Web: www.komproment.com

NOTE: Komproment makes these drawings available in the versions that currently exist. All use of the drawings is undertaken at own risk and liability. The drawings are regularly updated with relevant updates/changes on our website. You are responsible for keeping up-to-date with these changes. The drawings are made available in the following formats: PDF and DWG. All drawings are for guidance only. We make no guarantee that the drawings are suitable for all purposes.

**KOMPROMENT**  
DANISH BUILDING DESIGN

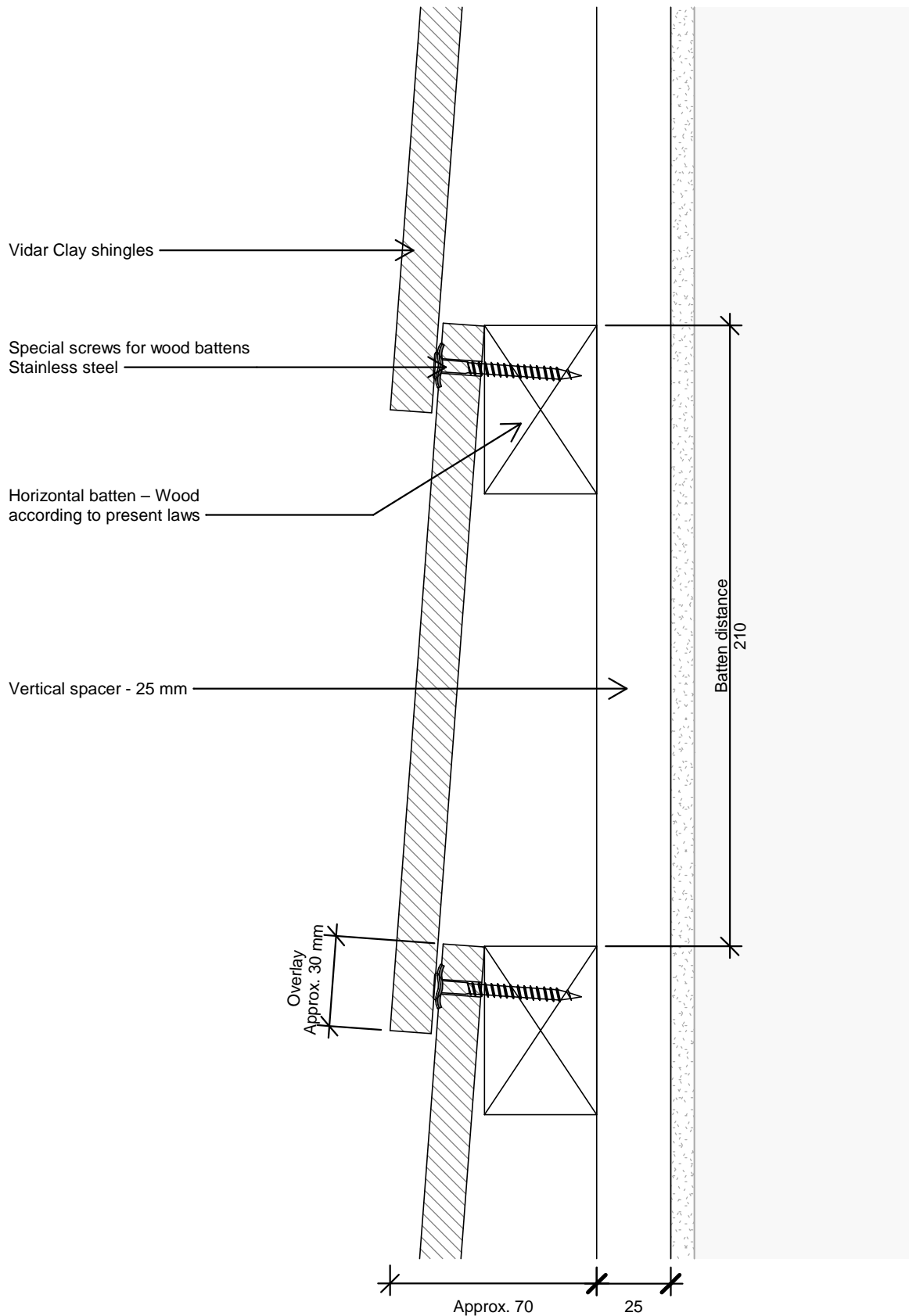

The drawing is not to scale. All measurements are in mm.

Copyright © Komproment Danish Building Design

T-1-2	Vertical view - wood batten		
Date: 01-01-2021	1 : 2	<b>VIDAR Clay Shingles</b>	Tel.: +45 96520710 E-Mail: Export@komproment.dk Web: www.komproment.com

NOTE: Komproment makes these drawings available in the versions that currently exist. All use of the drawings is undertaken at own risk and liability. The drawings are regularly updated with relevant updates/changes on our website. You are responsible for keeping up-to-date with these changes. The drawings are made available in the following formats: PDF and DWG. All drawings are for guidance only. We make no guarantee that the drawings are suitable for all purposes.

**KOMPROMENT**  
DANISH BUILDING DESIGN

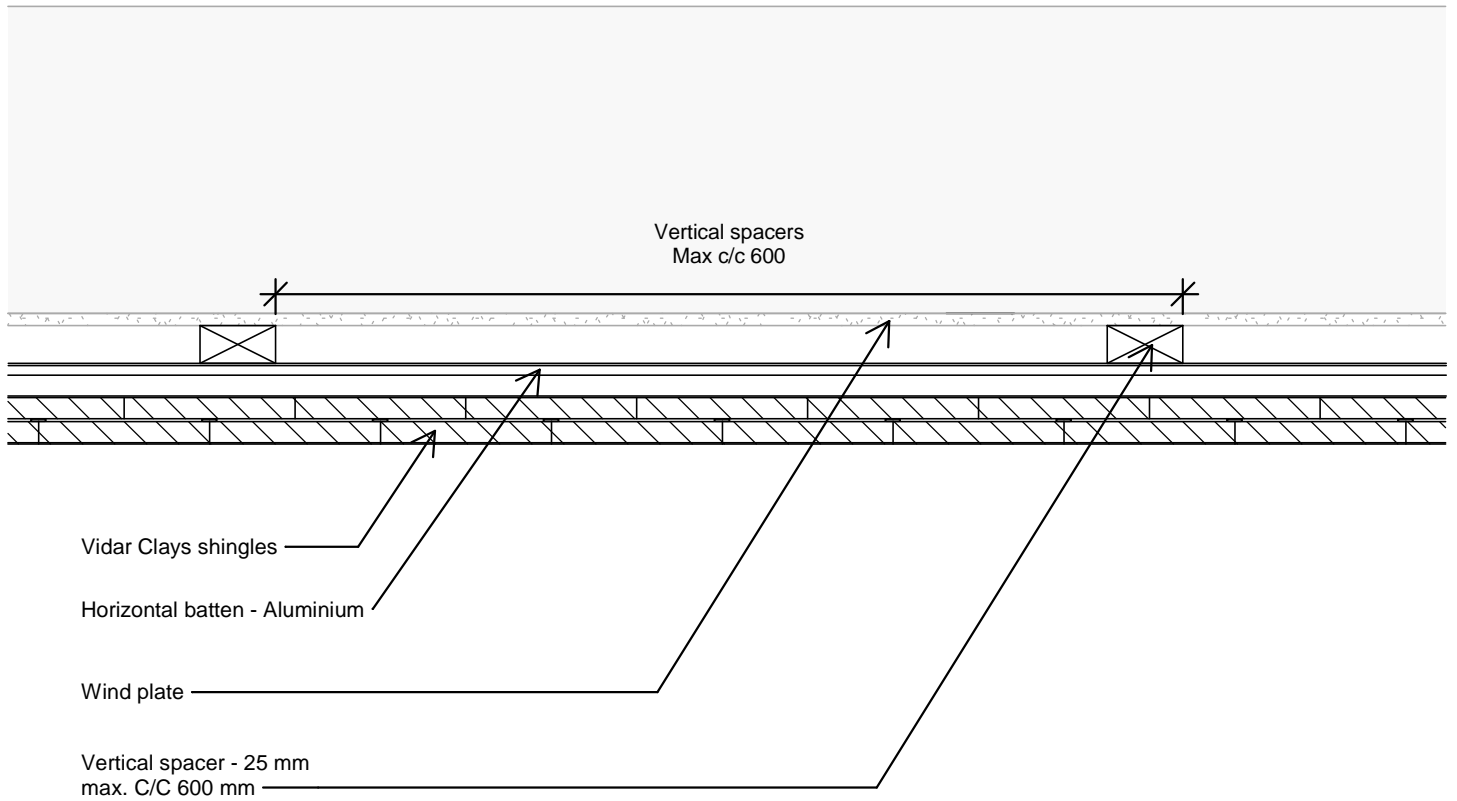

The drawing is not to scale. All measurements are in mm.

Copyright © Komproment Danish Building Design

T-2	Horizontal view		
Date: 01-01-2021	1 : 5	<b>VIDAR Clay Shingles</b>	Tel.: +45 96520710 E-Mail: Export@komproment.dk Web: www.komproment.com

NOTE: Komproment makes these drawings available in the versions that currently exist. All use of the drawings is undertaken at own risk and liability. The drawings are regularly updated with relevant updates/changes on our website. You are responsible for keeping up-to-date with these changes. The drawings are made available in the following formats: PDF and DWG. All drawings are for guidance only. We make no guarantee that the drawings are suitable for all purposes.

**KOMPROMENT**  
DANISH BUILDING DESIGN

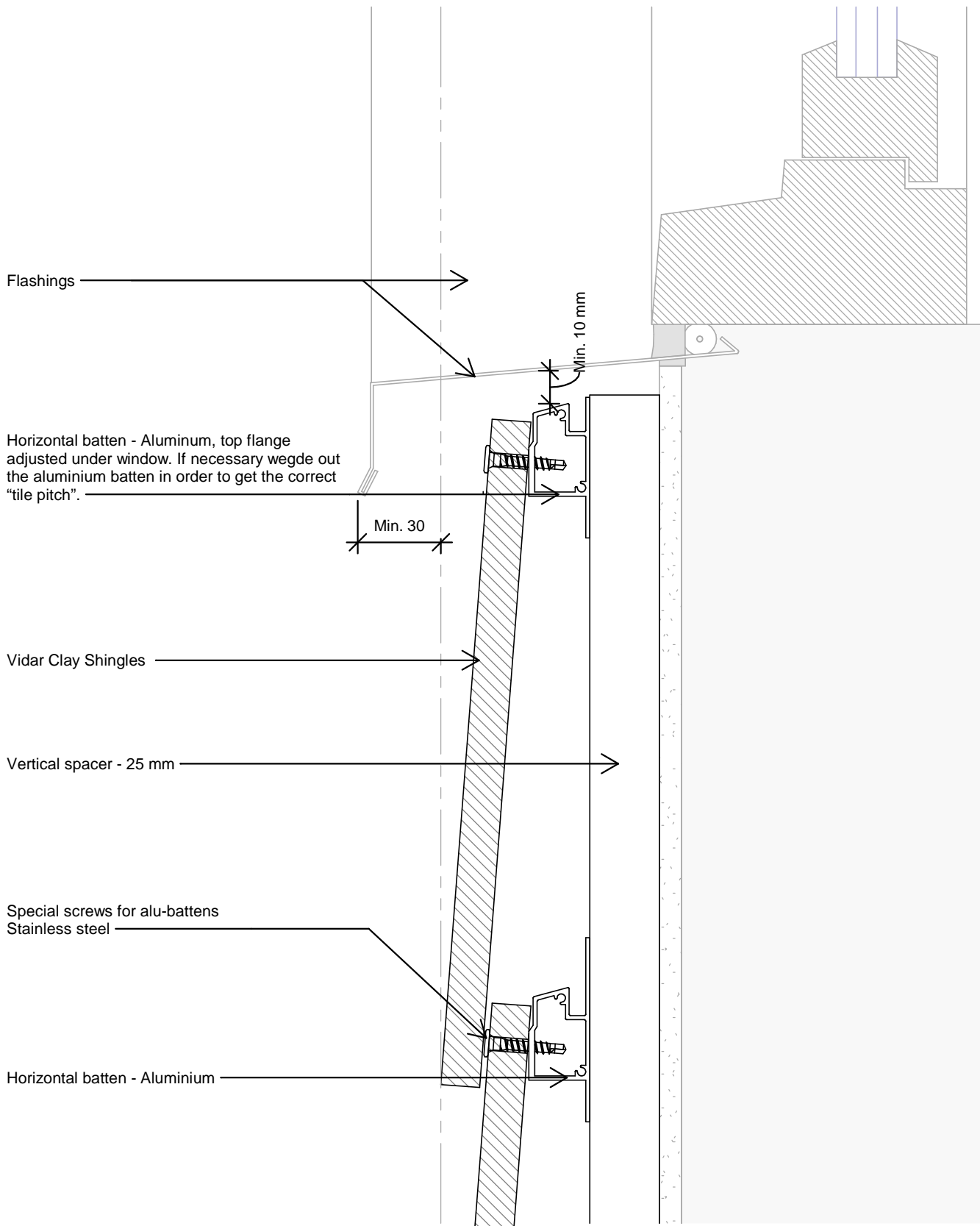

The drawing is not to scale. All measurements are in mm.

Copyright © Komproment Danish Building Design

T-3

Under window

Date: 01-01-2021

1 : 2

**VIDAR Clay Shingles**

Tel.: +45 96520710  
E-Mail: Export@komproment.dk  
Web: www.komproment.com

NOTE: Komproment makes these drawings available in the versions that currently exist. All use of the drawings is undertaken at own risk and liability. The drawings are regularly updated with relevant updates/changes on our website. You are responsible for keeping up-to-date with these changes. The drawings are made available in the following formats: PDF and DWG. All drawings are for guidance only. We make no guarantee that the drawings are suitable for all purposes.

**KOMPROMENT**  
DANISH BUILDING DESIGN

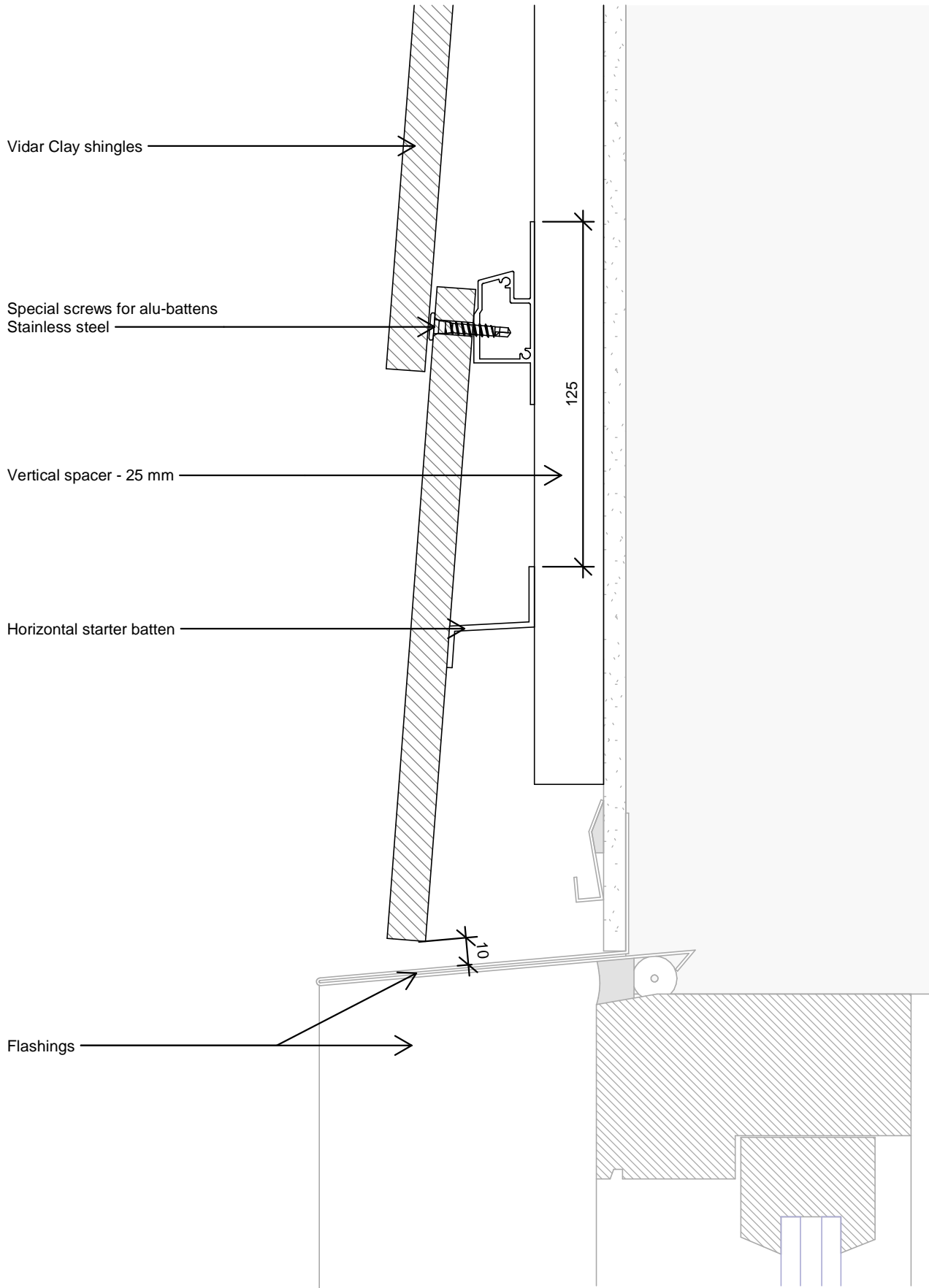

The drawing is not to scale. All measurements are in mm.

Copyright © Komproment Danish Building Design

T-4

Top window/door

Date: 01-01-2021

1 : 2

**VIDAR Clay Shingles**

Tel.: +45 96520710  
E-Mail: Export@komproment.dk  
Web: www.komproment.com

NOTE: Komproment makes these drawings available in the versions that currently exist. All use of the drawings is undertaken at own risk and liability. The drawings are regularly updated with relevant updates/changes on our website. You are responsible for keeping up-to-date with these changes. The drawings are made available in the following formats: PDF and DWG. All drawings are for guidance only. We make no guarantee that the drawings are suitable for all purposes.

**KOMPROMENT**  
DANISH BUILDING DESIGN

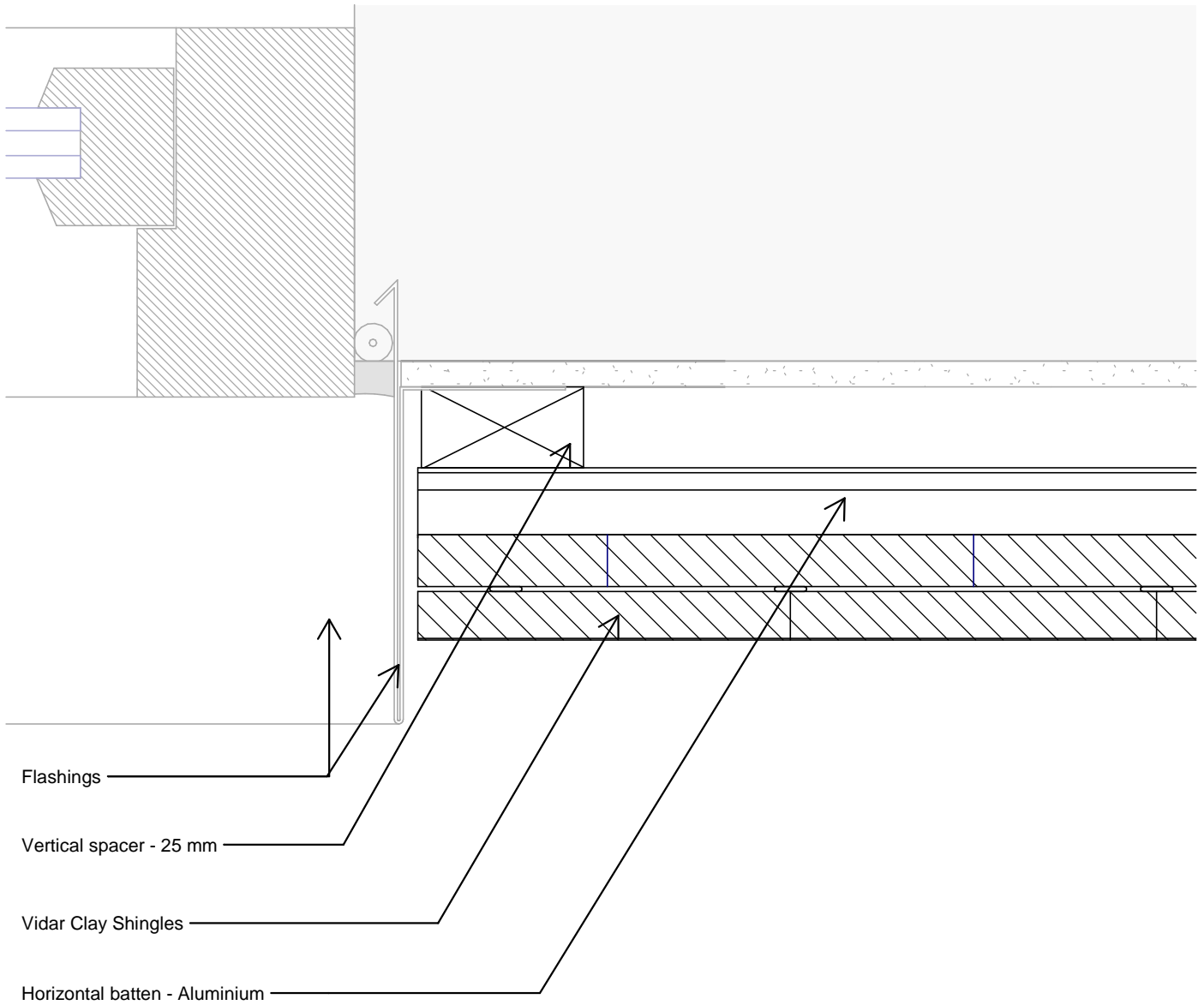

The drawing is not to scale. All measurements are in mm.

Copyright © Komproment Danish Building Design

T-5

Window/door - Horizontal view

Date: 01-01-2021

1 : 2

**VIDAR Clay Shingles**

Tel.: +45 96520710  
 E-Mail: Export@komproment.dk  
 Web: www.komproment.com

NOTE: Komproment makes these drawings available in the versions that currently exist. All use of the drawings is undertaken at own risk and liability. The drawings are regularly updated with relevant updates/changes on our website. You are responsible for keeping up-to-date with these changes. The drawings are made available in the following formats: PDF and DWG. All drawings are for guidance only. We make no guarantee that the drawings are suitable for all purposes.

**KOMPROMENT**  
 DANISH BUILDING DESIGN

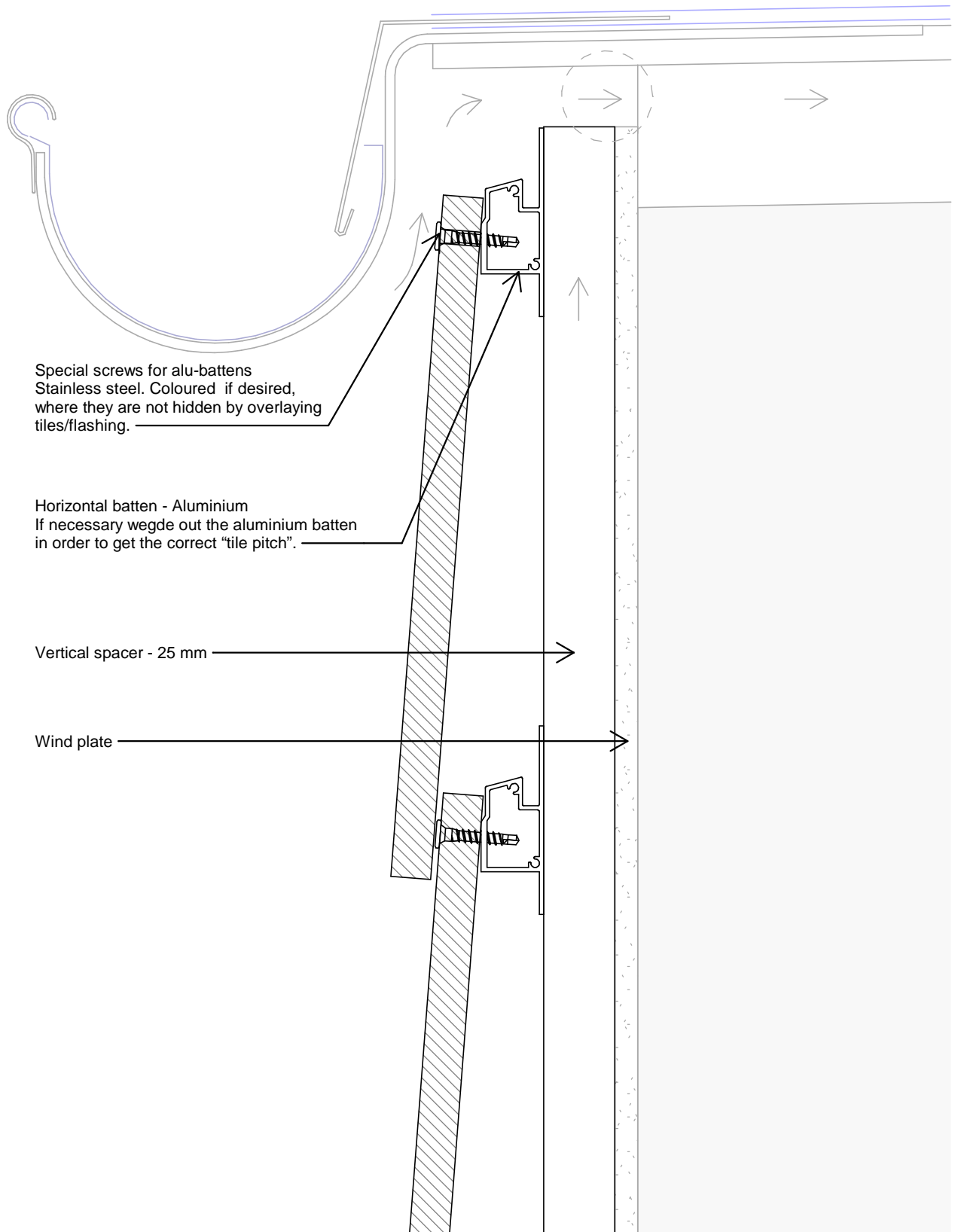

The drawing is not to scale. All measurements are in mm.

Copyright © Komproment Danish Building Design

T-6

Eave

Date: 01-01-2021

1 : 2

**VIDAR Clay Shingles**

Tel.: +45 96520710  
E-Mail: Export@komproment.dk  
Web: www.komproment.com

NOTE: Komproment makes these drawings available in the versions that currently exist. All use of the drawings is undertaken at own risk and liability. The drawings are regularly updated with relevant updates/changes on our website. You are responsible for keeping up-to-date with these changes. The drawings are made available in the following formats: PDF and DWG. All drawings are for guidance only. We make no guarantee that the drawings are suitable for all purposes.

**KOMPROMENT**  
DANISH BUILDING DESIGN



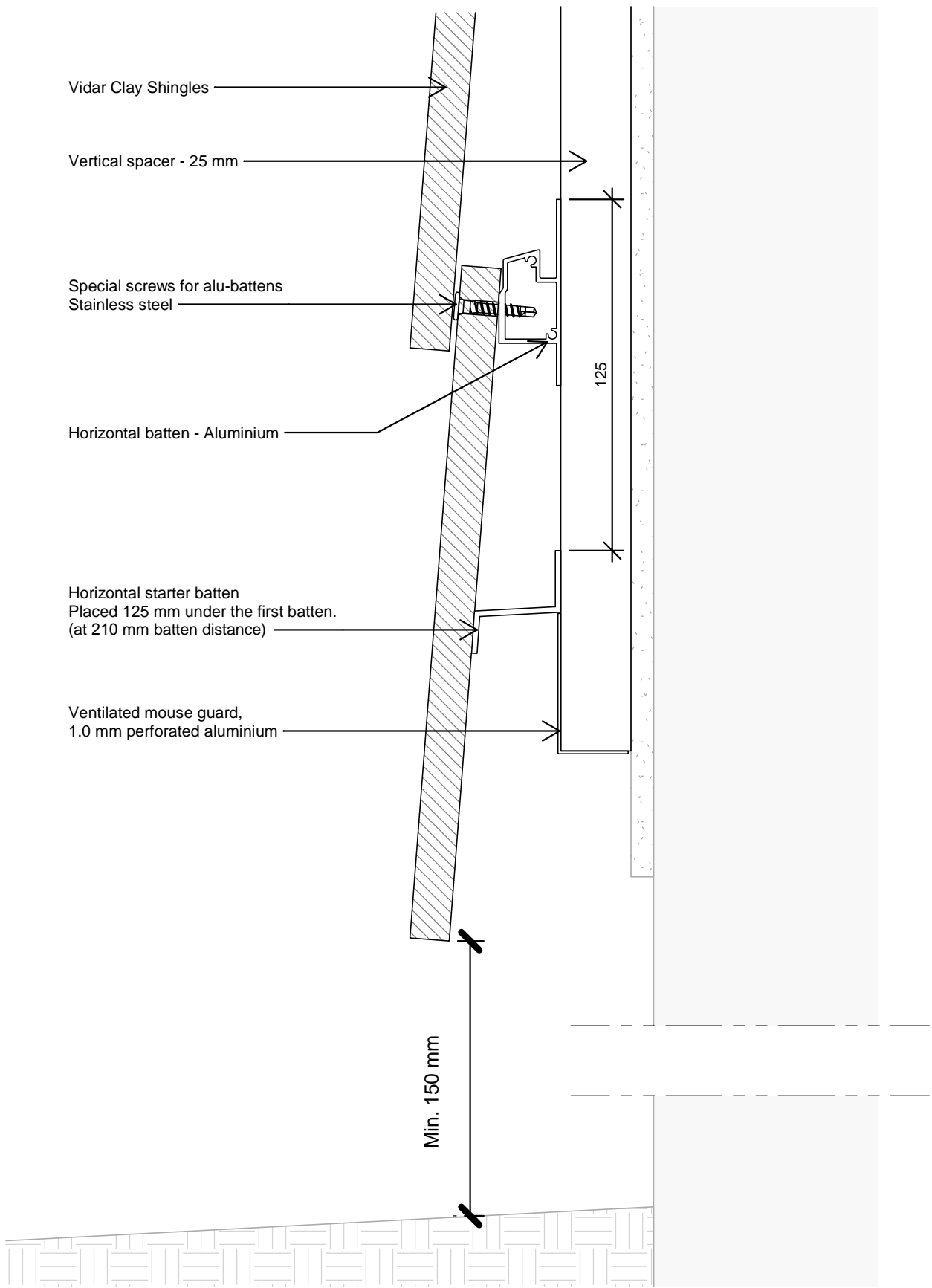

The drawing is not to scale. All measurements are in mm.

Copyright © Komproment Danish Building Design

T-7

Start facade - alu-batten

Date: 01-01-2021

1 : 2

**VIDAR Clay Shingles**

Tel.: +45 96520710  
E-Mail: Export@komproment.dk  
Web: www.komproment.com

NOTE: Komproment makes these drawings available in the versions that currently exist. All use of the drawings is undertaken at own risk and liability. The drawings are regularly updated with relevant updates/changes on our website. You are responsible for keeping up-to-date with these changes. The drawings are made available in the following formats: PDF and DWG. All drawings are for guidance only. We make no guarantee that the drawings are suitable for all purposes.

**KOMPROMENT**  
DANISH BUILDING DESIGN

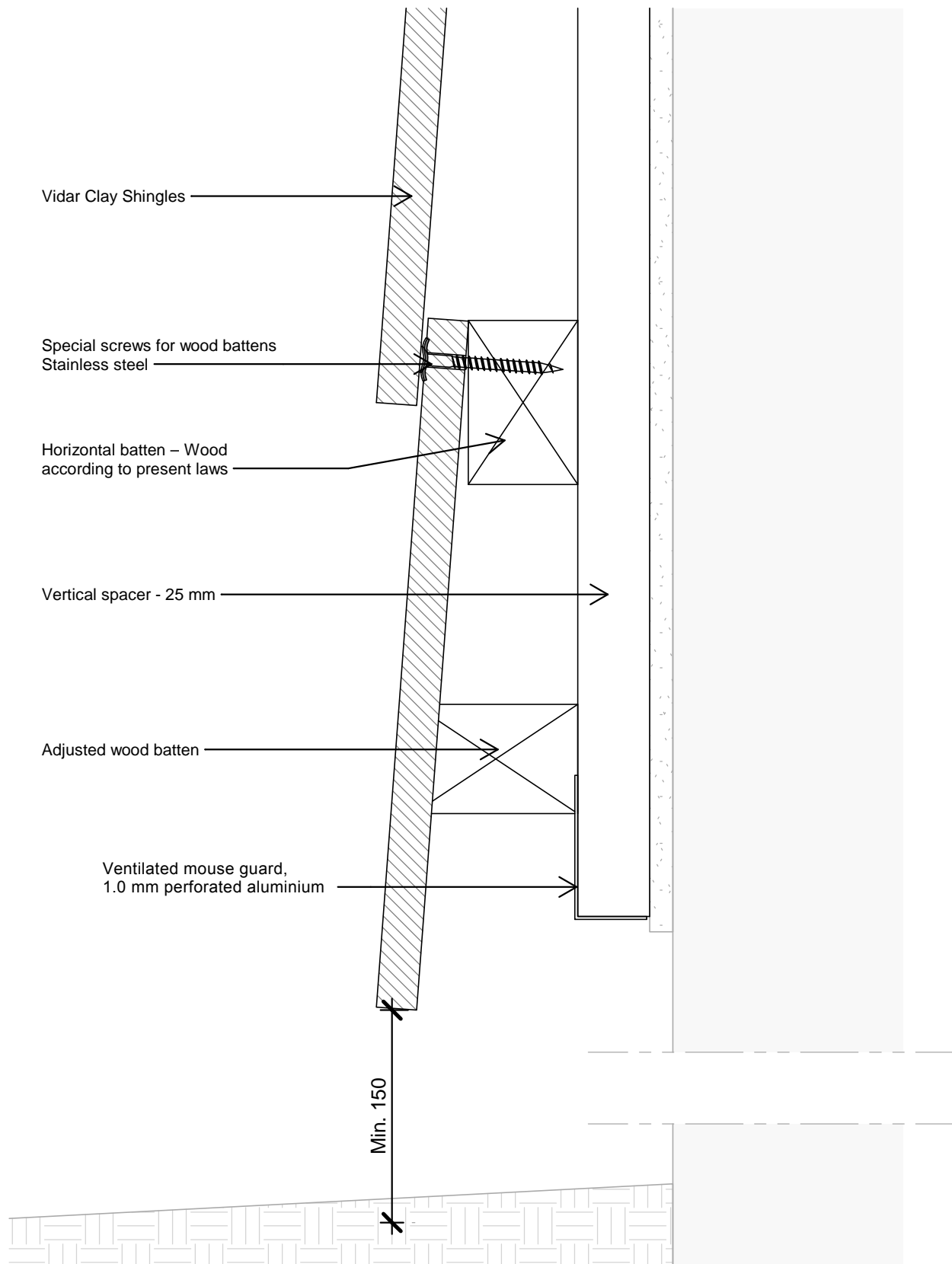

The drawing is not to scale. All measurements are in mm.

Copyright © Komproment Danish Building Design

T-7-2

Start facade - wood batten

Date: 01-01-2021

1 : 2

**VIDAR Clay Shingles**

Tel.: +45 96520710  
E-Mail: Export@komproment.dk  
Web: www.komproment.com

NOTE: Komproment makes these drawings available in the versions that currently exist. All use of the drawings is undertaken at own risk and liability. The drawings are regularly updated with relevant updates/changes on our website. You are responsible for keeping up-to-date with these changes. The drawings are made available in the following formats: PDF and DWG. All drawings are for guidance only. We make no guarantee that the drawings are suitable for all purposes.

**KOMPROMENT**  
DANISH BUILDING DESIGN

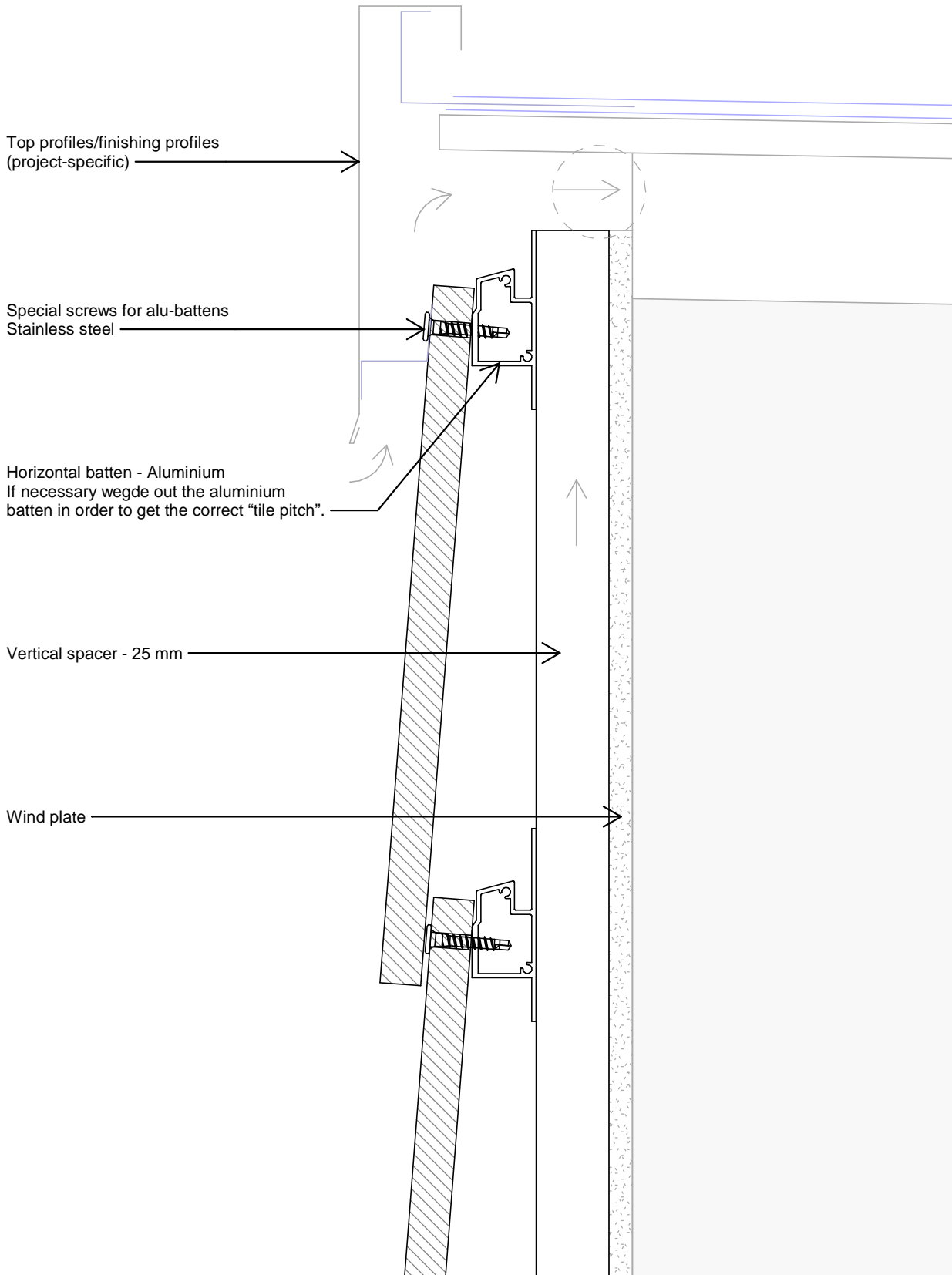

The drawing is not to scale. All measurements are in mm.

Copyright © Komproment Danish Building Design

T-8	Gable		
Date: 01-01-2021	1 : 2	<b>VIDAR Clay Shingles</b>	Tel.: +45 96520710 E-Mail: Export@komproment.dk Web: www.komproment.com

NOTE: Komproment makes these drawings available in the versions that currently exist. All use of the drawings is undertaken at own risk and liability. The drawings are regularly updated with relevant updates/changes on our website. You are responsible for keeping up-to-date with these changes. The drawings are made available in the following formats: PDF and DWG. All drawings are for guidance only. We make no guarantee that the drawings are suitable for all purposes.

**KOMPROMENT**  
DANISH BUILDING DESIGN

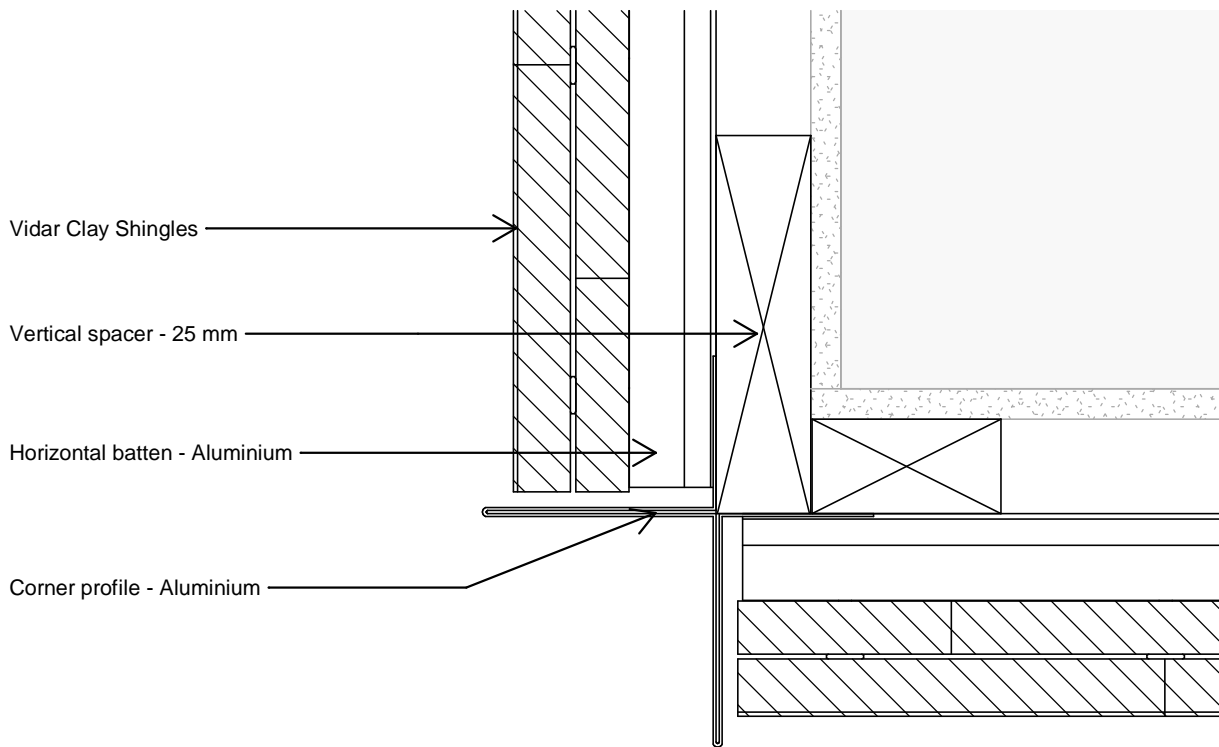
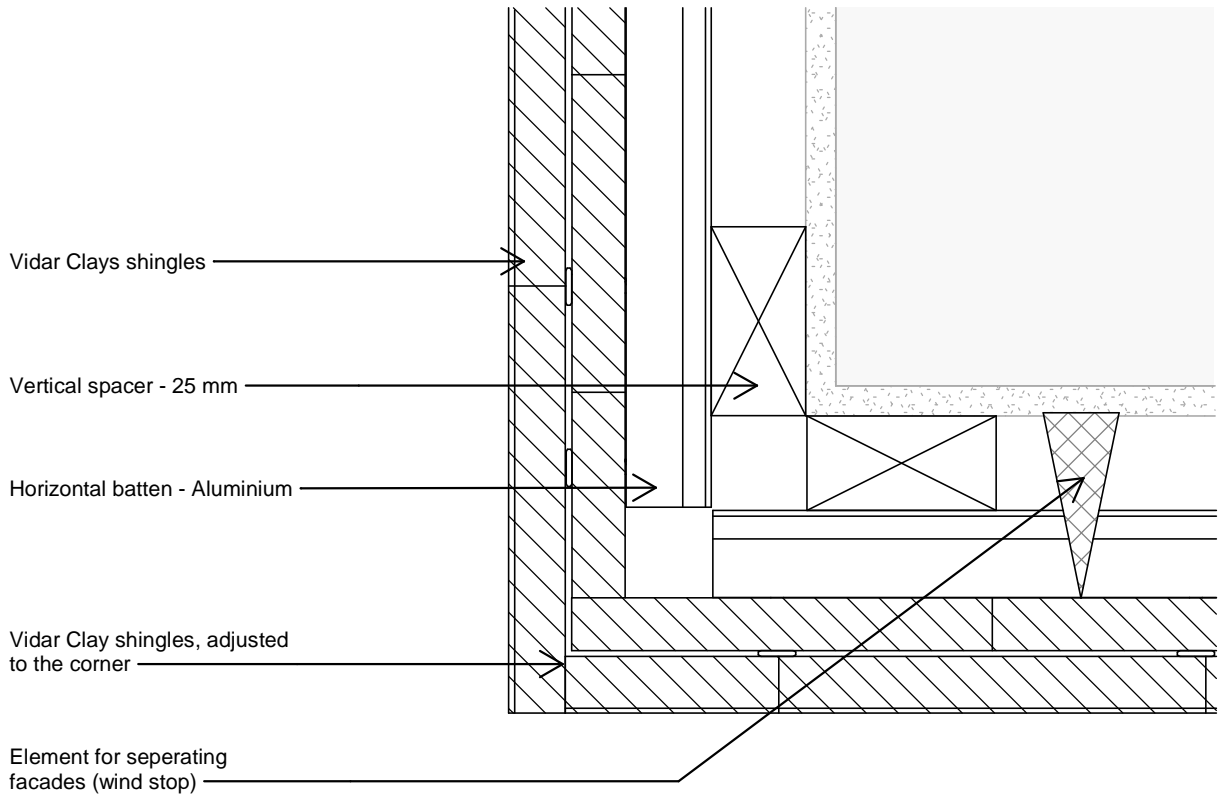

The drawing is not to scale. All measurements are in mm.

Copyright © Komproment Danish Building Design

T-9	Outside corner		
Date: 01-01-2021	1 : 2	<b>VIDAR Clay Shingles</b>	Tel.: +45 96520710 E-Mail: Export@komproment.dk Web: www.komproment.com

NOTE: Komproment makes these drawings available in the versions that currently exist. All use of the drawings is undertaken at own risk and liability. The drawings are regularly updated with relevant updates/changes on our website. You are responsible for keeping up-to-date with these changes. The drawings are made available in the following formats: PDF and DWG. All drawings are for guidance only. We make no guarantee that the drawings are suitable for all purposes.

**KOMPROMENT**  
DANISH BUILDING DESIGN

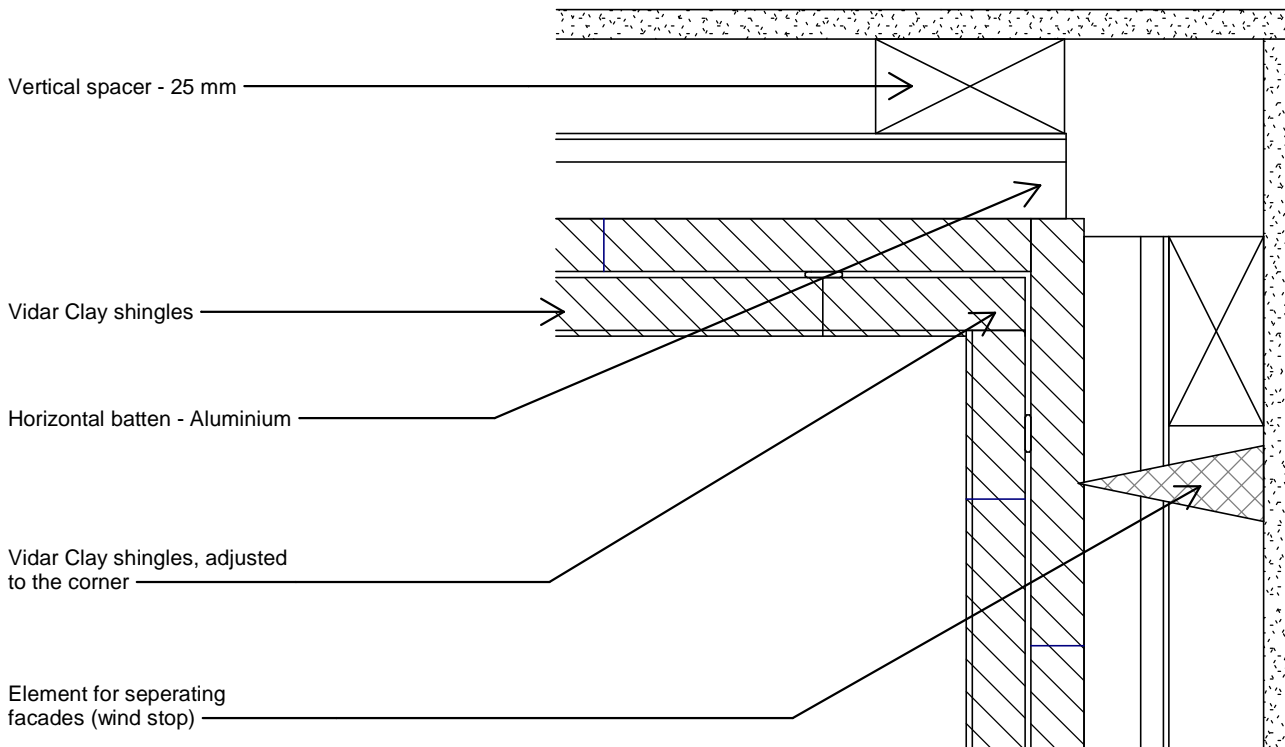
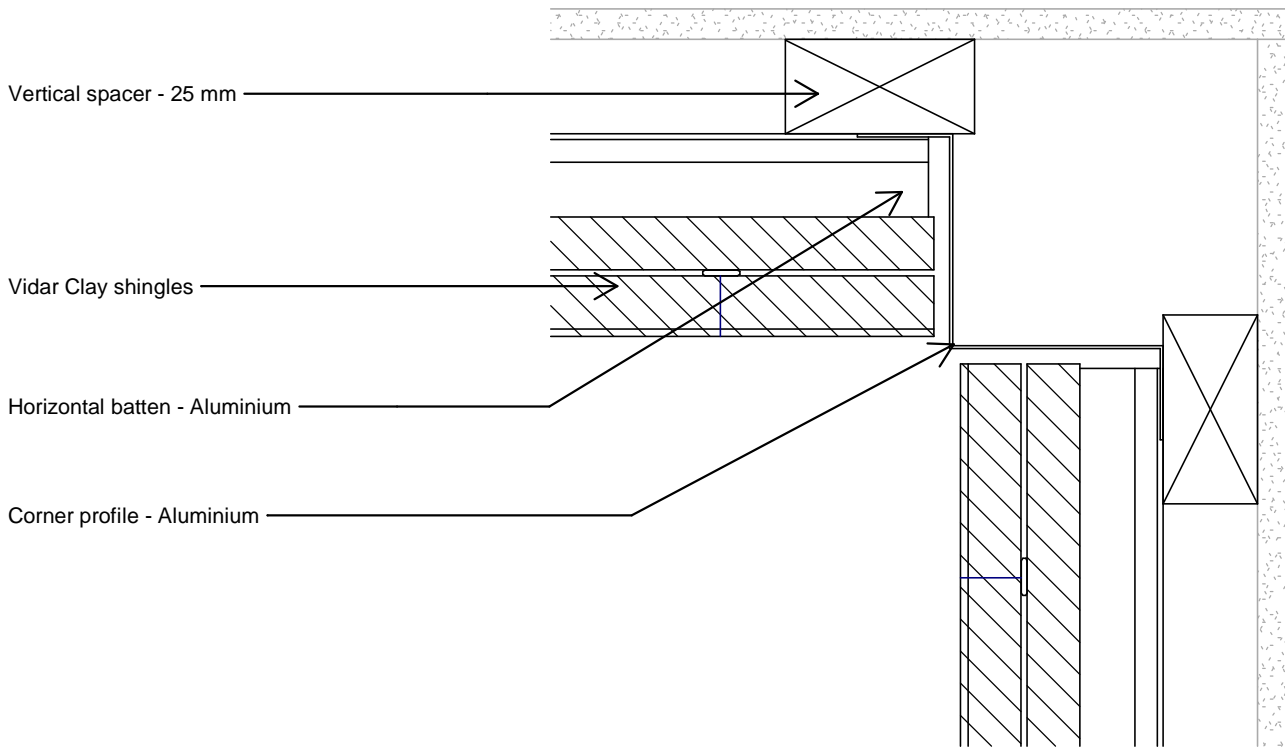

The drawing is not to scale. All measurements are in mm.

Copyright © Komproment Danish Building Design

T-10	Inside corner		
Date: 01-01-2021	1 : 2	<b>VIDAR Clay Shingles</b>	Tel.: +45 96520710 E-Mail: Export@komproment.dk Web: www.komproment.com

NOTE: Komproment makes these drawings available in the versions that currently exist. All use of the drawings is undertaken at own risk and liability. The drawings are regularly updated with relevant updates/changes on our website. You are responsible for keeping up-to-date with these changes. The drawings are made available in the following formats: PDF and DWG. All drawings are for guidance only. We make no guarantee that the drawings are suitable for all purposes.

**KOMPROMENT**  
DANISH BUILDING DESIGN

# General information

VIDAR Clay Shingles is tile facade system for covering existing as well as new buildings.

The facade system can be mounted directly onto the existing facade, on wooden frames or using aluminium battens. The VIDAR Clay Shingles facade system is Cradle to Cradle certified at silver level.

The drawings and instructions are prepared for facades mounted in Denmark, Norway and Sweden, on the basis of installation on a wooden substructure.

Attachment between the substructure and the load-bearing building sections is not part of these instructions and must fulfil applicable standards and regulations at all times, as well as being documented in the specific projects.

## Flatness tolerances for the back wall

Always check the substructure before mounting battens. Straightness requirement for the underlying structure, vertical and horizontal, tolerance: +/- 3 mm, measured with straightedge over 2 m.

## Flashings

All flashings around windows, doors, gables, eaves etc. in Komproment's drawings and instructions are examples only. All flashings must be reviewed, designed and planned out for the individual project.

Flashing is therefore not kept in stock by Komproment

## Technical support

If you need advice and/or technical support, you can always count on our assistance when you need it.

Komproment can help with:

- Getting started on installation at the start of larger projects
- Discussions about detail solutions
- Input for the descriptive material
- Other problems/issues

For technical support, contact us by calling: +45 96520710 or by email to [export@komproment.dk](mailto:export@komproment.dk)  
Opening times: Monday-Thursday: 8:00-16:00, Friday: 8:00-15:30

## General

Komproment cannot be held responsible for project design or for project details, which are the responsibility of the architect and/or consulting engineer supervising the project at all times.

Komproment's drawings and instructions must be considered as guidelines for the purpose of sharing Komproment's experience. Komproment is therefore solely responsible for the delivered building materials and the quality of these.

The drawing is not to scale. All measurements are in mm.

Copyright © Komproment Danish Building Design

T-11

General information

Date: 01-01-2021

**VIDAR Clay Shingles**

Tel.: +45 96520710  
E-Mail: [Export@komproment.dk](mailto:Export@komproment.dk)  
Web: [www.komproment.com](http://www.komproment.com)

NOTE: Komproment makes these drawings available in the versions that currently exist. All use of the drawings is undertaken at own risk and liability. The drawings are regularly updated with relevant updates/changes on our website. You are responsible for keeping up-to-date with these changes. The drawings are made available in the following formats: PDF and DWG. All drawings are for guidance only. We make no guarantee that the drawings are suitable for all purposes.

**KOMPROMENT**  
DANISH BUILDING DESIGN